

# Contactless Current Sensor Module for non-intrusive “clamp-on” installation

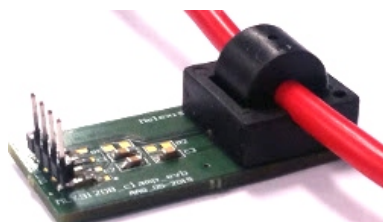

## Description

The clamp-on current sensor is designed for non-intrusive and isolated measurement of electric currents. Thanks to the clamp-on design, the contactless current sensor can be safely installed without the need to interrupt or cut the cable.

The module consists of a PCB including Hall sensor, clamp-on shield and the necessary components to straightforwardly install and operate. Supplied with a DC voltage of 5V, the module provides a linear analog output voltage between 500 mV and 4500 mV as a function of the primary input current.

Applications include DC and AC current sensing up to 100 kHz, motor control, battery monitoring, charge control, white goods, and many more.

## Characteristics

Parameter	Typical Value	Unit
Primary input current	$\pm 75$ <sup>1)</sup>	A
Output voltage	$\pm 2000$ (swing)	mV
	500...4500 (range)	mV
Sensitivity	$26$ <sup>1)</sup>	mV/A
Operation frequency range	DC...100	kHz
Operation temperature range	-40 ... 85	°C
Supply voltage	5	V
Supply current	10	mA

<sup>1)</sup> other values available on request, e.g.,  $\pm 25$  A (80 mV/A),  $\pm 50$  A (40 mV/A)

## Module Overview Table

The primary current range and module sensitivity are programmable. The ranges and standard values are indicated in the table below.

Module	Wire Diameter (mm)	Current range (A), (std value)
CO-4-1.2-30-L	4	$\pm 5 \dots \pm 30$ , ( $\pm 30$ )
CO-4-1.2-75-H	4	$\pm 30 \dots \pm 75$ , ( $\pm 75$ )
CO-10-1.2-150-V60	10	$\pm 75 \dots \pm 150$ , ( $\pm 150$ )
CO-10-1.2-230-V40	10	$\pm 150 \dots \pm 230$ , ( $\pm 230$ )

### Application Example

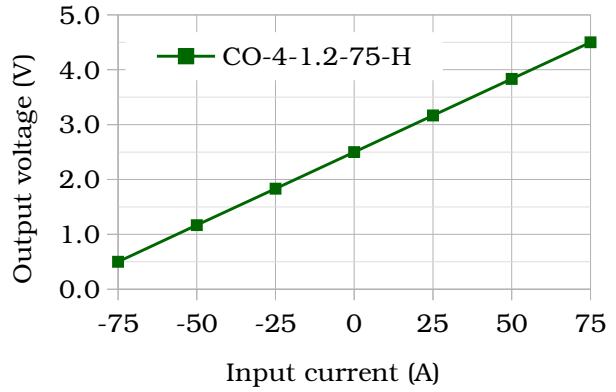
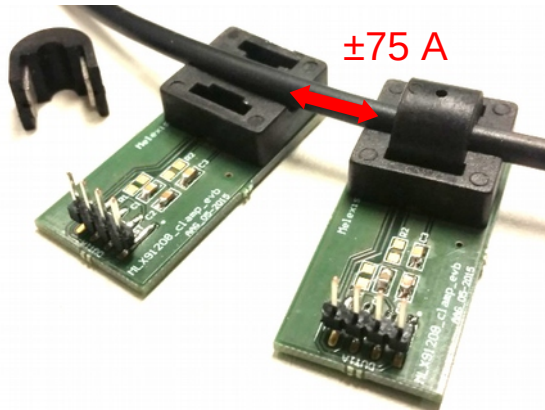

### Electrical Schematic & Pin-Out

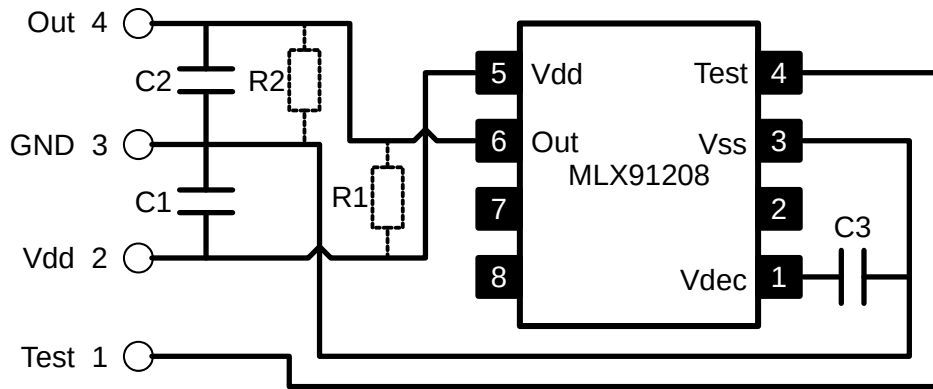

Pin	Description	Comment
1	Test	not used
2	Vdd	5V supply voltage
3	GND	0V
4	Out	Hall sensor analog output

### PCB Layout

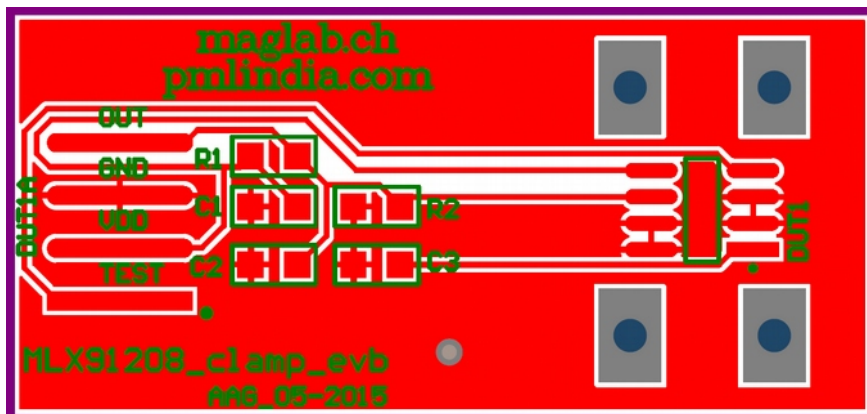

### Bill of Material

DUT1: MLX91208H (magnetic sensitivity 100 mV/mT)

C1: 100 nF

C2: 10 nF

C3: 47 nF

R1 or R2: 6 kOhm ... 100 kOhm (Pull-up or pull-down resistor for diagnostics)\*

\*For further information, please refer to the MLX91208 datasheet [available online].

### Module Dimensions

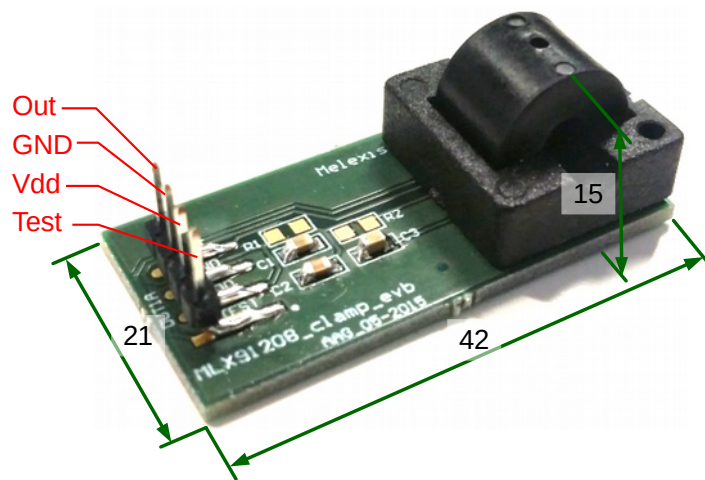

### Shield Dimensions

CO-4-1.2: Cable diameter = 4 mm

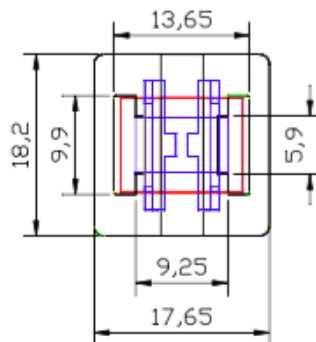
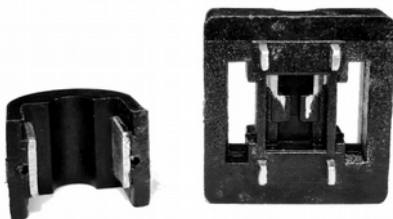
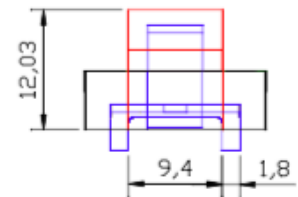
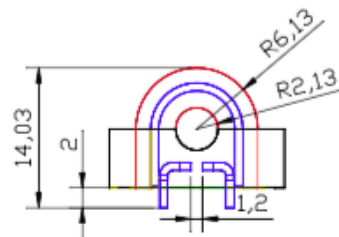
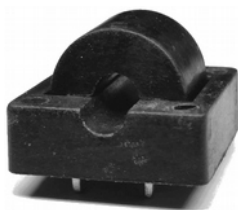

**Please contact us at**



maglab GmbH

Güterstrasse 141  
CH-4053 Basel  
Switzerland

+41 61 261 16 44  
info@maglab.ch  
www.maglab.ch



Permanent Magnets Ltd.

Plot no 22, Mira Co Operative Industrial  
Estate Miraroad-East, Thane-401104,  
Maharashtra, India

+91 22 28 45 41 64  
sales@pml.in  
www.pmlindia.com