

Manganin Shunt Resistor for High Precision Current Measurement

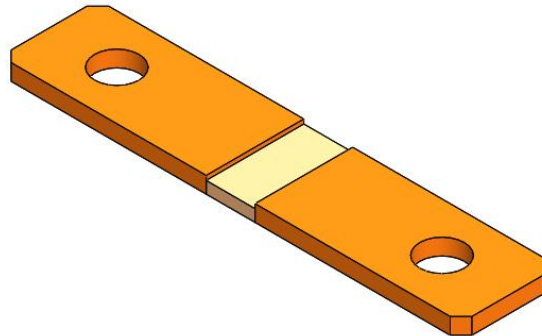

Description

The R100-BAR-03A shunt resistor is a precision Cu-Mn resistance. It consists of a Tin plated copper busbar with hole terminals for easy installation.

The shunt is designed for precision current measurement with high thermal stability in instruments, industrial, and automotive applications, typically including energy meters, ampere meters, power inverters, and battery current monitoring.

Characteristics

Parameter	Typical Value	Unit
Resistance	100 ±5%	μ Ohm
Temperature coefficient	±200	ppm/°C
Temperature coefficient (element material)	±20	ppm/°C
Operation temperature range	-40 to 125	°C
Storage range	-40 to 150	°C
Continuous power	5	W
Maximum power	36	W

Geometry

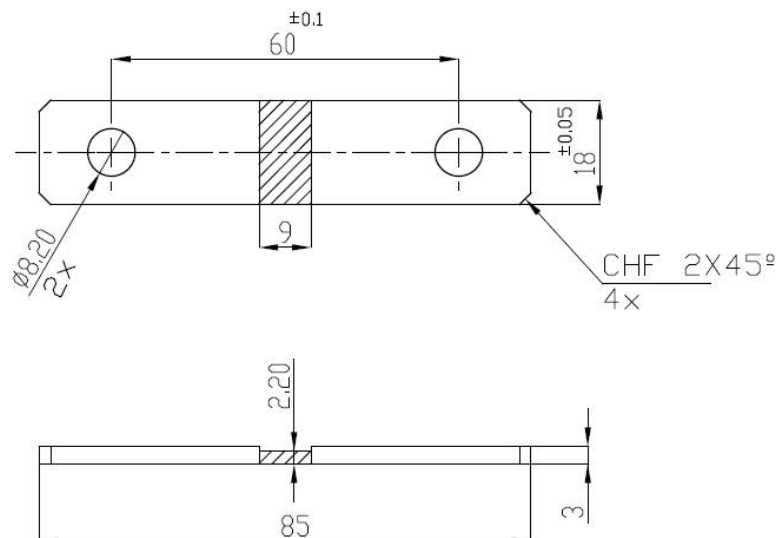

Please contact us at



maglab AG

Güterstrasse 141
CH-4053 Basel
Switzerland

+41 61 261 16 44
info@maglab.ch
www.maglab.ch



Permanent Magnets Ltd.

B-3, MIDC Industrial Area, Mira-gaon
Miraroad-East, Thane-401107, Maharashtra
India

+91 22 62 16 54 00
shuntinquiry@pml.in
www.pmlindia.com