

Contactless Current Sensor Module for non-intrusive “clamp-on” installation

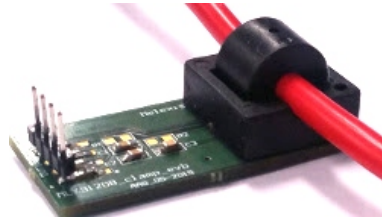

Description

The clamp-on current sensor is designed for non-intrusive and isolated measurement of electric currents. Thanks to the clamp-on design, the contactless current sensor can be safely installed without the need to interrupt or cut the cable.

The module consists of a PCB including Hall sensor, clamp-on shield and the necessary components to straightforwardly install and operate. Supplied with a DC voltage of 5V, the module provides a linear analog output voltage between 500 mV and 4500 mV as a function of the primary input current.

Applications include DC and AC current sensing up to 100 kHz, motor control, battery monitoring, charge control, white goods, and many more.

Characteristics

Parameter	Typical Value	Unit
Primary input current	± 75 ¹⁾	A
Output voltage	± 2000 (swing)	mV
	500...4500 (range)	mV
Sensitivity	26 ¹⁾	mV/A
Operation frequency range	DC...100	kHz
Operation temperature range	-40 ... 85	°C
Supply voltage	5	V
Supply current	10	mA

¹⁾ other values available on request, e.g., ± 25 A (80 mV/A), ± 50 A (40 mV/A)

Application Example

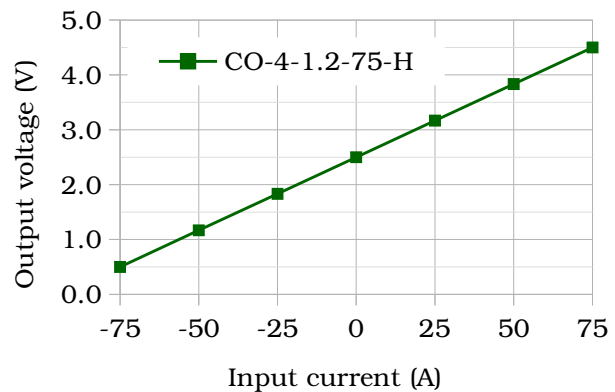
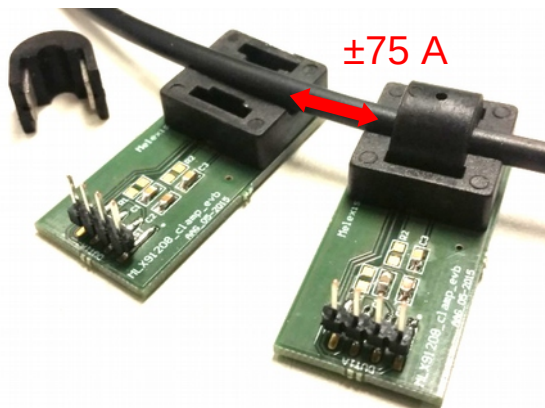

Electrical Schematic & Pin-Out

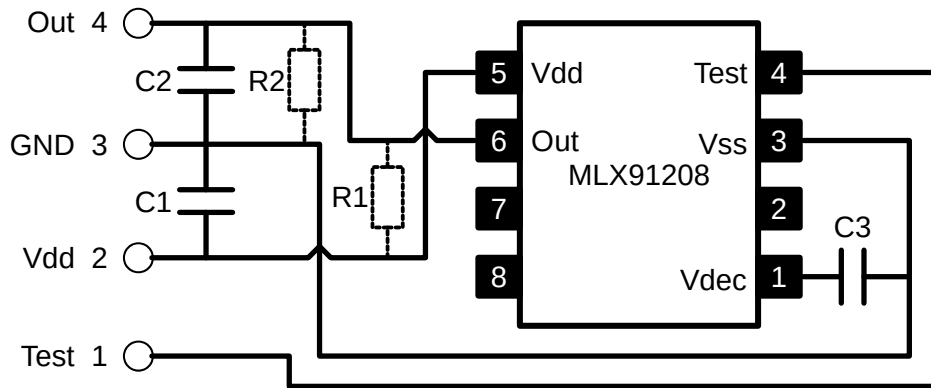

Pin	Description	Comment
1	Test	not used
2	Vdd	5V supply voltage
3	GND	0V
4	Out	Hall sensor analog output

PCB Layout

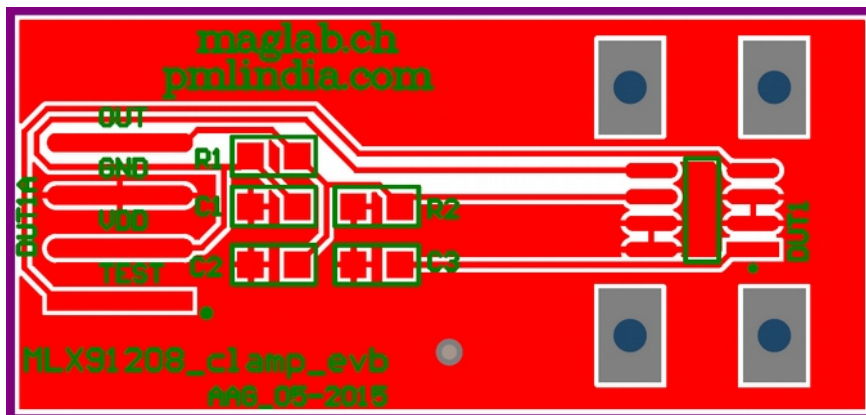

Bill of Material

DUT1: MLX91208H (magnetic sensitivity 100 mV/mT)

C1: 100 nF

C2: 10 nF

C3: 47 nF

R1 or R2: 6 kOhm ... 100 kOhm (Pull-up or pull-down resistor for diagnostics)*

*For further information, please refer to the MLX91208 datasheet [available online].

Module Dimensions

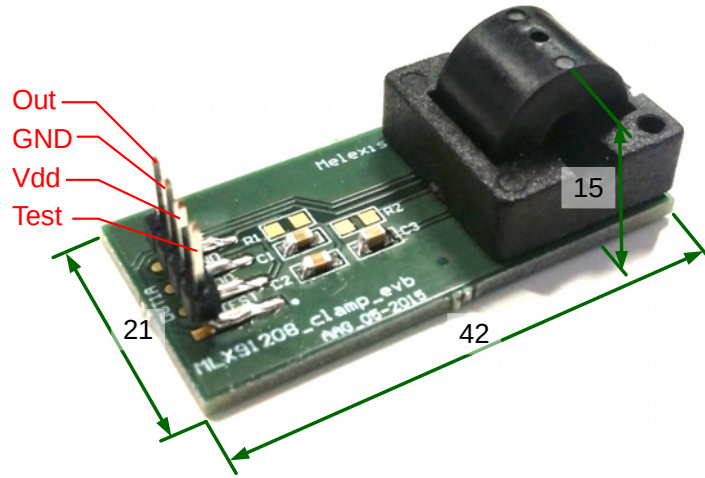

Shield Dimensions

CO-4-1.2: Cable diameter = 4 mm

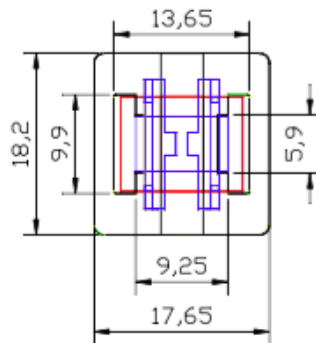
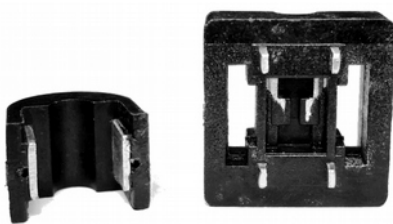
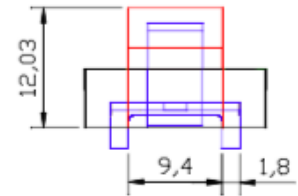
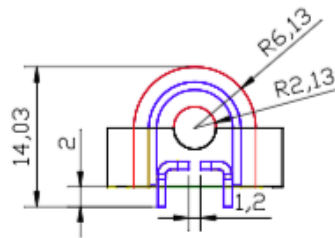
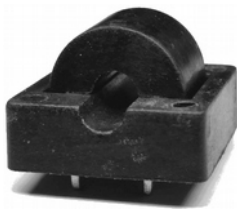

Please contact us at



maglab GmbH

Güterstrasse 141
CH-4053 Basel
Switzerland

+41 61 261 16 44
info@maglab.ch
www.maglab.ch



Permanent Magnets Ltd.

Plot no 22, Mira Co Operative Industrial
Estate Miraroad-East, Thane-401104,
Maharashtra, India

+91 22 28 45 41 64
sales@pml.in
www.pmlindia.com